

SYSTEM FLOW CHART

MAQUET
GETINGE GROUP

**ANESTHESIA SYSTEM
FLOW-i**



FLOW-i ANESTHESIA SYSTEM, SYSTEM VERSION 4.0

BASE UNIT

Fixed height version

MAQUET FLOW-i C20
66 77 200

- Base unit including:
 - Carrier with four wheels.
 - 15" touch screen.
 - Adjustable arm for up to two display units.
 - Two vaporizer connections.
 - Four "T" side slots for accessory mounting.
- Battery backup (90 minutes).
- Lamp.
- Integrated patient gas analyzer.
- Ventilation modes:
 - Manual ventilation.
 - Volume Control ventilation.
 - Pressure Control ventilation.
- Connections:
 - 2 x RS232 with FCI protocol.
 - 1 x USB.
 - 1 x VGA (output).
 - 1 x Ethernet (ready for Remote Services).
- Gas inlets:
 - O₂.
 - Air.
 - N₂O.
 - O₂, Air, N₂O backup prepared.
- Patient cassette and volume reflector.
- Country kit must be ordered separately (see below).

Electronically height adjustable version

MAQUET FLOW-i C30
66 77 300

- Base unit including:
 - Carrier (height adjustable) with four wheels.
 - One drawer with lock.
 - 15" touch screen.
 - Adjustable arm for up to two display units.
 - Two vaporizer connections.
 - Four "T" side slots for accessory mounting.
- Battery backup (90 minutes).
- Lamp.
- Integrated patient gas analyzer.
- Ventilation modes:
 - Manual ventilation.
 - Volume Control ventilation.
 - Pressure Control ventilation.
- Connections:
 - 2 x RS232 with FCI protocol.
 - 1 x USB.
 - 1 x VGA (output).
 - 1 x Ethernet (ready for Remote Services).
- Gas inlets:
 - O₂.
 - Air.
 - N₂O.
 - O₂, Air, N₂O backup prepared.
- Patient cassette and volume reflector.
- Country kit must be ordered separately (see below).

• Table height: Adjustable 83 - 103 cm.

Ceiling pendant version

MAQUET FLOW-i C40
66 77 400

- Base unit including:
 - Carrier with small wheels for transport within OR.
 - 15" touch screen.
 - Adjustable arm for up to two display units.
 - Two vaporizer connections.
 - Four "T" side slots for accessory mounting.
- Battery backup (90 minutes).
- Lamp.
- Integrated patient gas analyzer.
- Ventilation modes:
 - Manual ventilation.
 - Volume Control ventilation.
 - Pressure Control ventilation.
- Connections:
 - 2 x RS232 with FCI protocol.
 - 1 x USB.
 - 1 x VGA (output).
 - 1 x Ethernet (ready for Remote Services).
- Gas inlets:
 - O₂.
 - Air.
 - N₂O.
 - O₂, Air, N₂O backup prepared.
- Patient cassette and volume reflector.
- Country kit must be ordered separately (see below).

Note! Not all products listed here are available in all countries. For details contact your sales representative.



= and/or
 = box for ordered quantity

Bold line = standard system configuration

Red text = upgrade of existing anesthesia systems

Green text = compatibility note

Two drawers

Two drawers, one with lock
66 82 232

- Factory mounting only.
- Table height:
 - Standard - with two drawers: 87 cm.

Three drawers

Three drawers, one with lock
66 81 882

- Factory mounting only.
- Table height:
 - With three drawers: 103 cm.

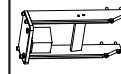

Pendant mounting kit, M-Lifting

66 89 202

One of the following heights must also be selected:

Interface height 560 mm 66 89 207

Interface height 645 mm 66 89 210

Interface height 778 mm 66 89 212

More information regarding required height is found in the FLOW-i Data sheet.

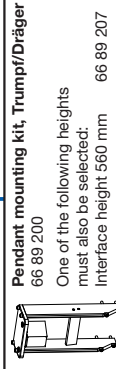

Pendant mounting kit, Trumpf/Dräger
66 89 200

One of the following heights must also be selected:

Interface height 560 mm 66 89 207

Interface height 645 mm 66 89 210

Interface height 778 mm 66 89 212

More information regarding required height is found in the FLOW-i Data sheet.

M-Lifting system

For more information please contact Maquet Surgical Workplaces.

Lifting system

Local delivery.

One drawer

One drawer with lock
66 88 687

- Factory mounting only.

Two drawers

Two drawers, one with lock
66 82 232

- Factory mounting only.

COUNTRY KIT

FLOW-i country kit	
Bulgarian	European power cable 66 88 257
Chinese	Chinese power cable 66 86 697
Czech	European power cable 66 88 275
Danish	European power cable 66 88 282
Dutch	European power cable 66 78 412
English/CAN	North Am. power cable 66 78 372
English/SG	UK power cable 66 92 667
English/TW	North Am. power cable 68 81 558
English/US	North Am. power cable 66 88 752
English	European power cable 66 78 375
English	European power cable 66 78 377
Estonian	European power cable 66 88 265
Finnish	European power cable 66 86 692
French/CAN	North Am. power cable 66 78 385
French	European power cable 66 78 387
French	European power cable 66 78 390
French	European power cable 66 78 392
German	European power cable 66 78 380
German	European power cable 66 78 382
Greece	European power cable 66 88 267
Hungarian	European power cable 66 88 272
Italian	European power cable 66 78 402
Japanese	North Am. power cable 66 95 192
Lithuanian	European power cable 66 88 260
Norwegian	European power cable 66 86 695
Polish	European power cable 66 88 277
Portuguese	European power cable 66 78 407
Portuguese/BR	Brazilian power cable 66 78 410
Portuguese/BR/115 V	Brazilian power cable 66 94 750
Romanian	European power cable 66 87 587
Russian	European power cable 66 86 702
Serbian	European power cable 66 88 930
Slovak	European power cable 66 88 280
Spanish	European power cable 66 78 395
Spanish	North Am. power cable 66 78 397
Spanish	North Am. power cable 66 78 400
Swedish	European power cable 66 78 405
Turkish	European power cable 66 88 270
Vietnamese	European power cable 66 88 262

- Including:
 - Gas inlet connections.
 - Mains power inlet cable, 3.5 m.
 - User's manual.
 - Quick reference guide.
- Alternative mains power cable can be ordered separately (see below).

• Factory mounting only.

FOR UPGRADE OF INSTALLED FLOW-i ANESTHESIA MACHINES:

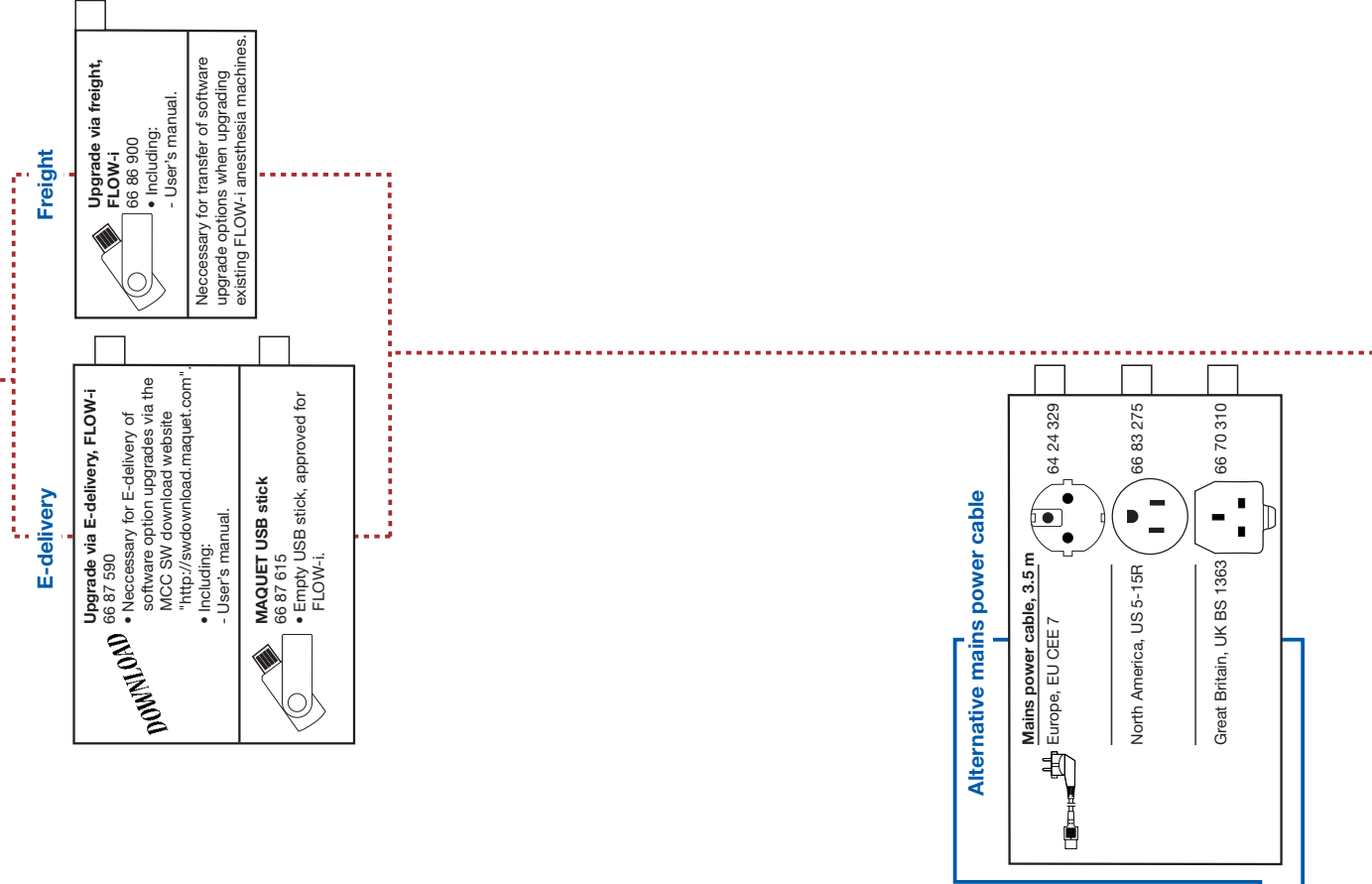

STARTER KIT CONSUMABLES

One selected kit may be ordered with every FLOW-i

22 mm patient tubes

Starter kit Anesthesia, adult, 22 mm
66 96 810

- Including:
 - 1 pc of Set of breathing circuit, 22 mm, disposable (20 pcs: 66 92 205).
 - 1 pc of Servo Duo Guard viral/bacterial filter (60 pcs: 66 71 775).
 - 1 pc of Anesthesia mask, disposable, Size 4, medium adult (20 pcs: 66 92 242).

10 mm patient tubes

Starter kit anesthesia, infant, 10 mm mm
66 96 712

- Including:
 - 1 pc of Set of breathing circuit, 10 mm, disposable (20 pcs: 66 92 210).
 - 1 pc of Servo Duo Guard viral/bacterial filter (60 pcs: 66 71 775).
 - 1 pc of Anesthesia mask, reusable, Size 0, small infant (10 pcs: 66 92 225).

ADDITIONAL VENTILATION MODES

Extended ventilation package
66 88 205

- Pressure support with backup.
- PRVC.
- SIMV.

Pressure Support with backup
66 88 200

SIMV
66 88 197

PRVC
66 88 202

GAS CONTROL MODES

AGC™ Automatic Gas Control
68 81 990

ADDITIONAL FRESH GAS FLOW

Software option AFGO (Additional Fresh Gas Outlet)
66 81 887

AFGO adapter kit FLOW-i
66 86 857

AFGO adapter kit, on-site upgrade: Order no. 66 86 860.

EXTRA MAINS POWER OUTLETS

Without extra mains power outlets
Standard configuration 115V 66 82 295
Standard configuration 230V 66 82 297

Extra mains power outlets, IEC, 3 pcs

- With Isolation transformer. 66 80 177
- 115 V 66 80 180
- 230 V 66 80 180

• Factory mounting only.

Integrated patient monitor power cable
66 87 100

• Factory mounting only.

GAS OUTLETS

Gas outlets

- 1 x O₂ + 1 x Air

AGA	66 80 312
NIST	66 81 890
French std	66 81 892
DISS	66 81 895

O₂ FLOWMETER / SUCTION EQUIPMENT

Gas hose kit for auxiliary O₂ and suction module

O ₂ + Air, AGA/ISO color	66 82 170
O ₂ + Air, NIST/ISO color	66 82 172
O ₂ + Air, French std./ISO color	66 82 175
O ₂ + Air, DISS/US color	66 88 892
O ₂ + Air, NIST/UK color	66 89 867

Auxiliary O₂ and suction module
66 79 847

- Including:
 - Rear handle for base unit.
 - Hydrofobic bacterial/viral filter, 5 pcs.
 - Silicone rubber tube between suction ejector and suction bottle, length 1 m, internal diameter 6 mm.

Angled adapter for sterile water container
66 81 900

Hydrofobic bacterial/viral filter
57 500 630 *

- For Auxiliary O₂ and suction module.
- Disposable.

* Order from Maquet KG, Rastatt, Business Unit MEDAP, phone +49-7222-932-0.

Suction accessories

For more information please contact Maquet KG, Rastatt, Business Unit MEDAP, phone +49-7222-932-0.

BACKUP GAS SUPPLY

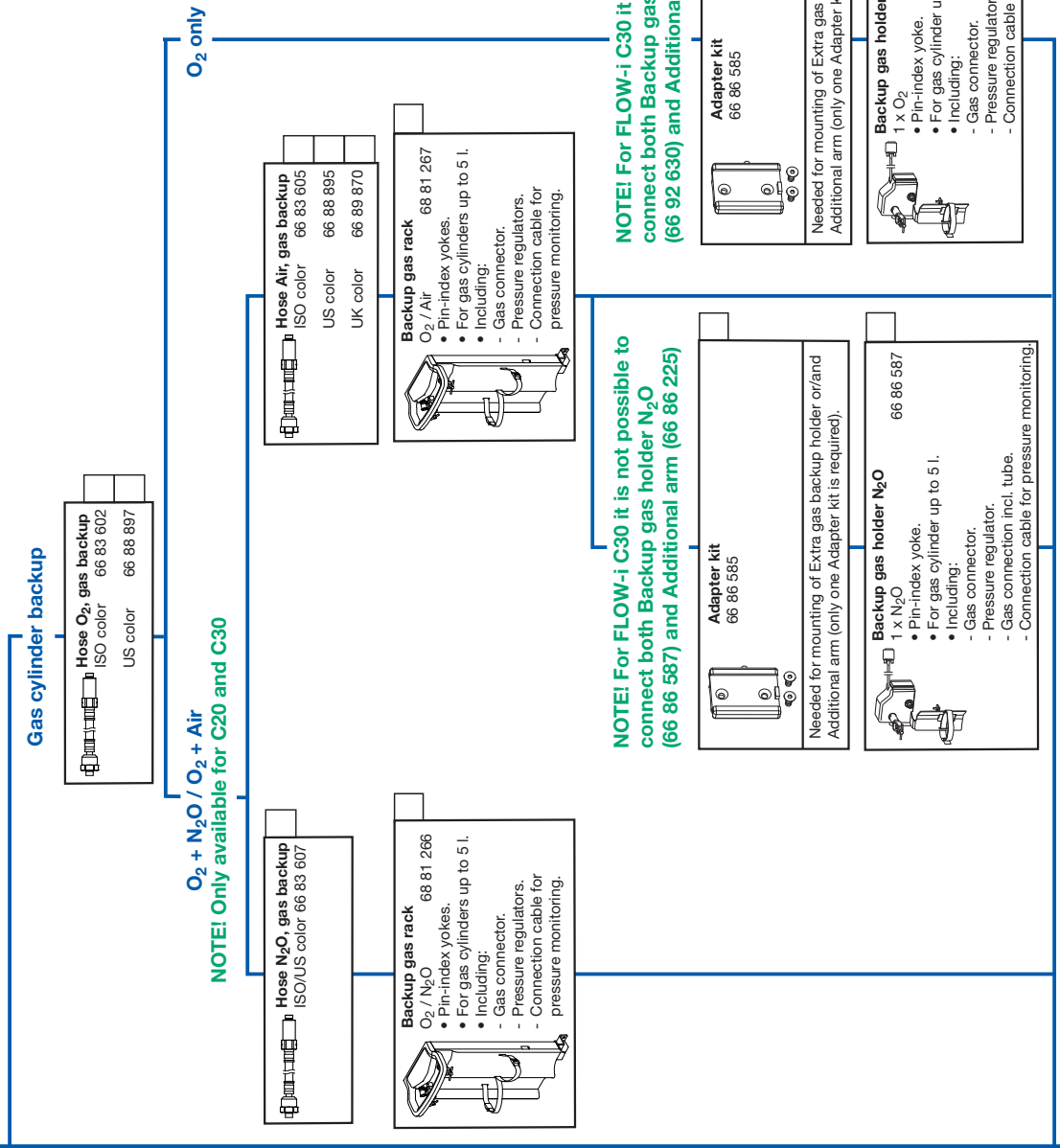

Gas cylinder backup

Hose O₂, gas backup
 ISO color 66 83 602
 US color 66 88 897

O₂ + N₂O / O₂ + Air
NOTE! Only available for C20 and C30

Hose N₂O, gas backup
 ISO/US color 66 83 607

Backup gas rack
 O₂ / N₂O 68 81 266

- Pin-index yokes.
- For gas cylinders up to 5 l.
- Including:
 - Gas connector.
 - Pressure regulator/s.
 - Connection cable for pressure monitoring.

Hose Air, gas backup
 ISO color 66 83 605
 US color 66 88 895
 UK color 66 89 870

Backup gas rack
 O₂ / Air 68 81 267

- Pin-index yokes.
- For gas cylinders up to 5 l.
- Including:
 - Gas connector.
 - Pressure regulators.
 - Connection cable for pressure monitoring.

NOTE! For FLOW-i C30 it is not possible to connect both Backup gas holder N₂O (66 86 587) and Additional arm (66 86 225)

Adapter kit
 66 86 585

Needed for mounting of Extra gas backup holder or/and Additional arm (only one Adapter kit is required).

Backup gas holder N₂O
 66 86 587

- Pin-index yoke.
- For gas cylinder up to 5 l.
- Including:
 - Gas connector.
 - Pressure regulator.
 - Gas connection incl. tube.
 - Connection cable for pressure monitoring.

NOTE! For FLOW-i C30 it is not possible to connect both Backup gas holder O₂ (66 92 630) and Additional arm (66 86 225)

Adapter kit
 66 86 585

Needed for mounting of Extra gas backup holder or/and Additional arm (only one Adapter kit is required).

Backup gas holder O₂
 66 92 630

- Pin-index yoke.
- For gas cylinder up to 5 l.
- Including:
 - Gas connector.
 - Pressure regulator.
 - Connection cable for pressure monitoring.

PATIENT MONITORING MOUNTINGS

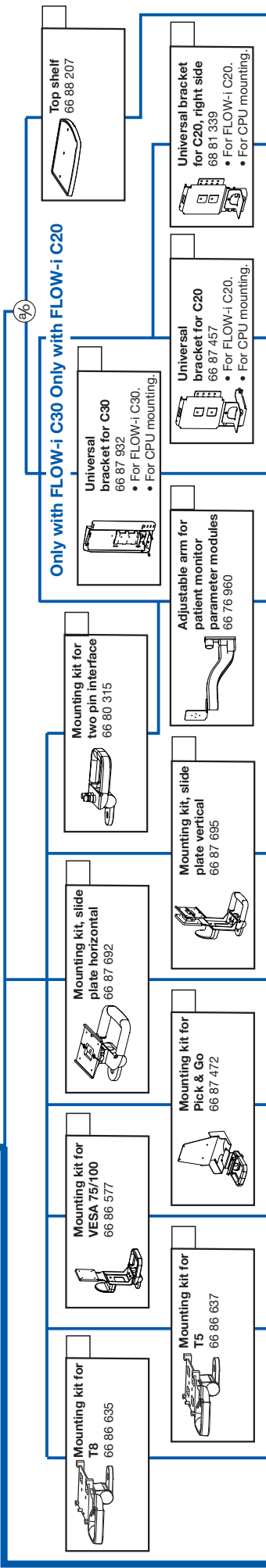

VAPORIZER

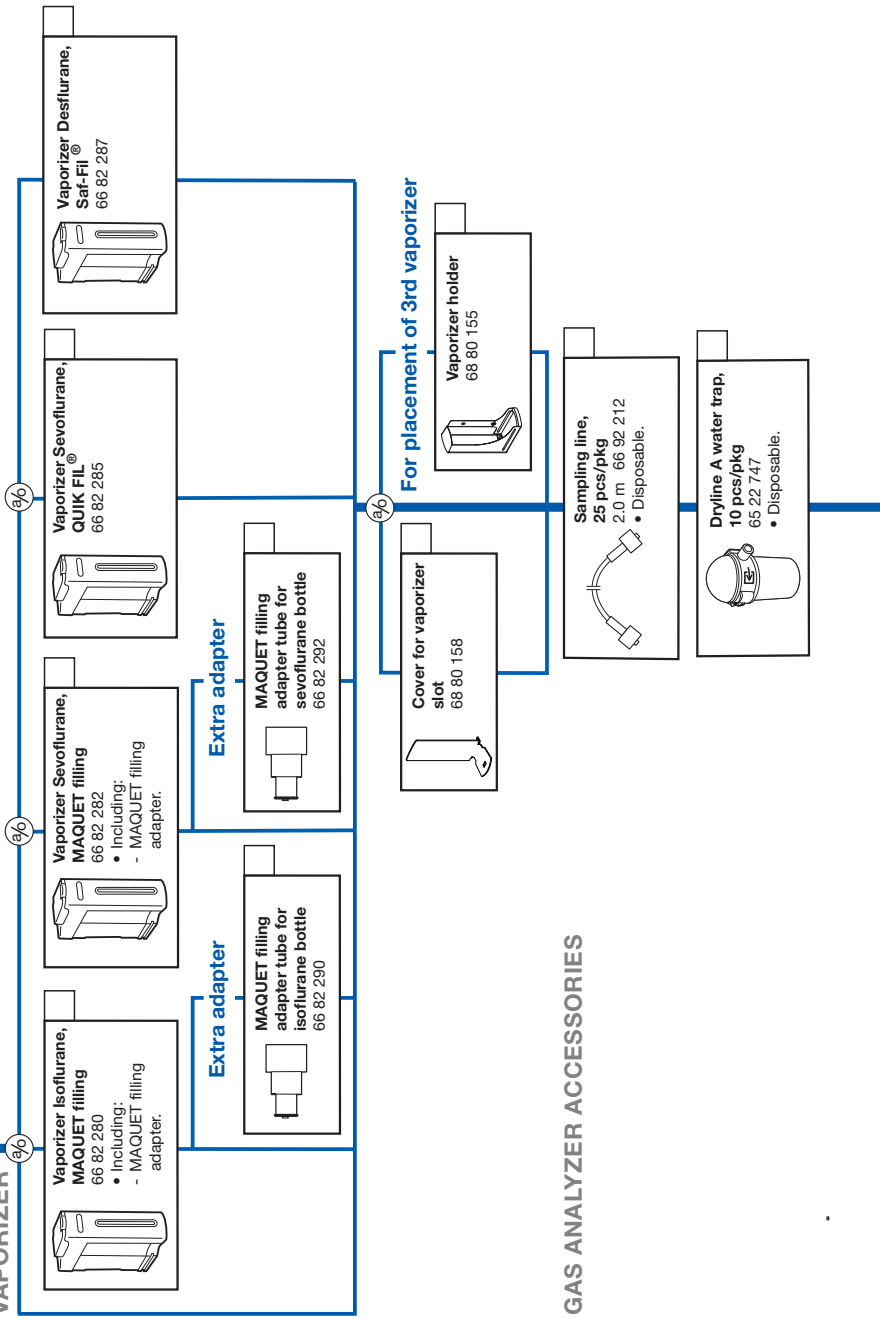

GAS ANALYZER ACCESSORIES

GAS EVACUATION (ANESTHETIC GAS SCAVENGING)

Evac outlet connection

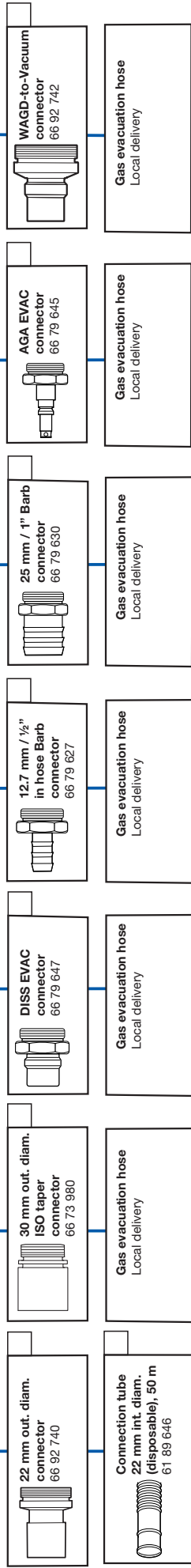

Central scavenging system

For restriction of excessive EVAC flow



GAS SUPPLY

AGA connections, ISO Color markings

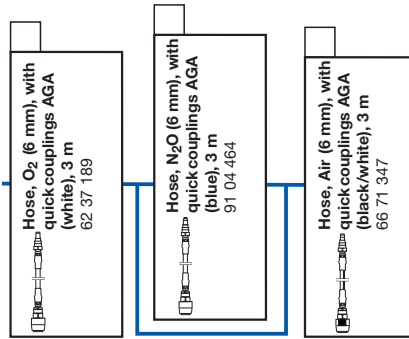

NIST/German connections, ISO Color markings

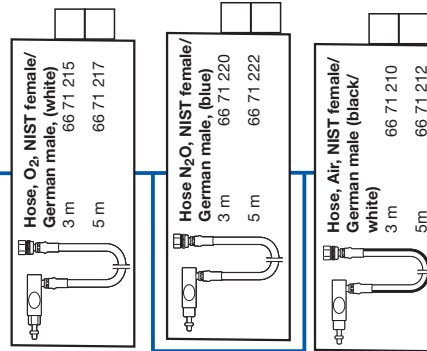

NIST connections, ISO Color markings

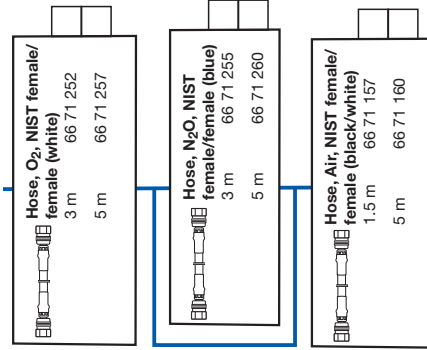

French standard connections, ISO Color markings

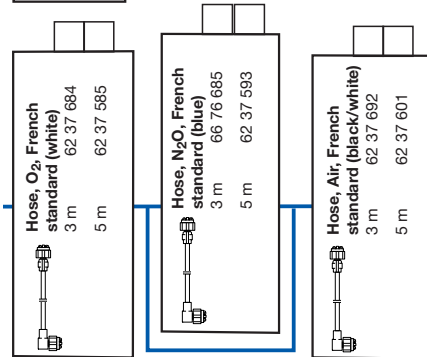

DISS connections, US Color markings

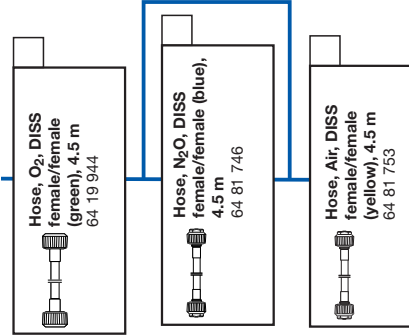

MANUAL VENTILATION

22 mm patient tubes

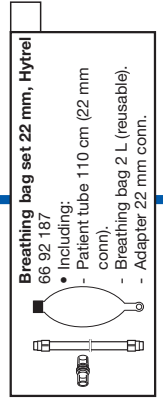

15 mm patient tubes

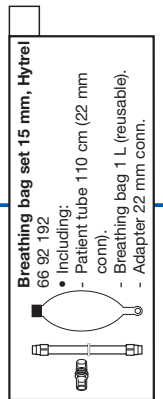

10 mm patient tubes

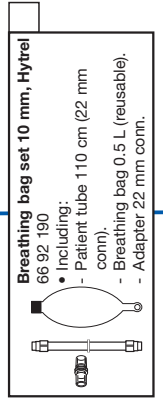

Alternative breathing bag

Reusable

Breathing bag, reusable
0.5 L 66 92 195
1 L 66 92 197
2 L 66 92 200
3 L 66 92 202

Disposable

Breathing bag, disposable, 20 pcs/pkg
0.5 L 66 92 215
1 L 66 92 217
2 L 66 92 220
3 L 66 92 222

VIRAL/BACTERIAL FILTER

Servo DuoGuard
viral/bacterial filter,
60 pcs/pkg
66 71 775

PATIENT CONNECTION

Reusable

22 mm patient tubes
15 mm patient tubes
10 mm patient tubes

Breathing circuit, 22 mm, Hyrel (1.5 m)
66 92 180
• Including:
- 2 x Patient tube 150 cm (22 mm conn).
- Y-piece 22 mm conn.
- Angled adapter 22/15 mm conn. with luer-lock port.

Breathing circuit, 15 mm, Hyrel (1.5 m)
66 92 182
• Including:
- 2 x Patient tube 150 cm (22/15 mm conn).
- Y-piece 22/15 mm conn.
- Angled adapter 22/15 mm conn. with luer-lock port.

Breathing circuit, 10 mm, Hyrel (1.5 m)
66 92 185
• Including:
- 2 x Patient tube 150 cm (22/10 mm conn).
- Angled Y-piece with luer-lock port, 15/10 mm conn.

Disposable

22 mm patient tubes
15 mm patient tubes
10 mm patient tubes

Set of breathing circuit, 22 mm, Disposable (1.5 m), 20 pcs/pkg
66 92 205
• Including:
- Patient tubes (smooth-bore), 22 mm diameter, 150 cm.
- Manual bag tube (smooth-bore), 22 mm, 100 cm.
- Latex-free manual bag, 2 L.
- Y-piece.
- Gas sampling line, 2.0 m.
- Elbow connector with gas sampling port.

Set of breathing circuit, 15 mm, Disposable (1.2 m), 20 pcs/pkg
66 92 207
• Including:
- Patient tubes (smooth-bore), 15 mm diameter with 22 mm connectors, 120 cm.
- Manual bag tube (smooth-bore), 15 mm diameter with 22 mm connector, 120 cm.
- Latex-free manual bag, 1 L.
- Y-piece.
- Gas sampling line, 2.0 m.
- Elbow connector with gas sampling port.

Set of breathing circuit, 10 mm, Disposable (1.2 m), 20 pcs/pkg
66 92 210
• Including:
- Patient tubes (smooth-bore), 10 mm diameter with 22 mm connectors, 120 cm.
- Manual bag tube (smooth-bore), 10 mm diameter with 22 mm connector, 120 cm.
- Latex-free manual bag, 0.5 L.
- Y-piece.
- Gas sampling line, 2.0 m.
- Elbow connector with gas sampling port.

Reusable

Tube connector 22-15 mm, angled, 5 pcs/pkg
90 37 730

Tube joint/adaptor 22 mm
64 25 581
• 22 mm out. diam., 15 mm int. diam.

ANESTHESIA MASK

Reusable

Anesthesia mask, reusable, 10 pcs/pkg	
Size 0, small infant	66 92 225
Size 1, medium infant	66 92 227
Size 2, large infant	66 92 230
Size 3, small adult	66 92 232
Size 4, medium adult	66 92 235
Size 5, large adult	66 92 237



Disposable

Anesthesia mask, disposable, 20 pcs/pkg	
Size 3, small adult	66 92 240
Size 4, medium adult	66 92 242
Size 5, large adult	66 92 245
Size 6, XL adult	66 92 247

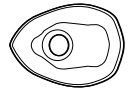

HARDWARE ACCESSORIES

DIN rail (10 x 25 mm)

Left (patient) side rail (max. 2 pcs)

Left side DIN rail (10 x 25 mm)
66 78 570
• For "T" side slot.

Right side rail (max. 2 pcs)

Right side DIN rail (10 x 25 mm)
66 78 572
• For "T" side slot.

Clamp, rail 10 x 25 mm
60 38 801
• For DIN rails.

Duoflex rail (10 x 30 mm)

Left (patient) side rail (max. 2 pcs)

Left side Duoflex rail (10 x 30 mm)
66 79 537
• For "T" side slot.

Right side rail (max. 2 pcs)

Right side Duoflex rail (10 x 30 mm)
66 79 542
• For "T" side slot.

Clamp, rail 10 x 30 mm
60 38 819
• For Duoflex rails.

Clamp, 1 slot
93 58 193
• For "T" side slot.

Hook with hook holder
93 68 952
Clamp must be ordered separately.

Vertical rail converter
66 89 740

NOTE! For FLOW-i C30 it is not possible to connect both Backup gas holder (N₂O/66 92 630 or O₂/66 86 587) and Additional arm (66 86 225)

Adapter kit
66 86 585



Needed for mounting of Extra gas backup holder or/and Additional arm (only one Adapter kit is required).

Additional arm
66 86 225

- Vertical and lateral motion.
- VESA 75/100 mm.

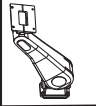

Additional table
66 76 962

- On flexible arm.
- Height adjustable.

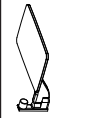

Manual breathing bag support arm, rigid
68 80 157

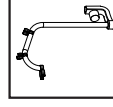

Manual breathing bag support arm
66 80 597



Cable support arm
66 87 487

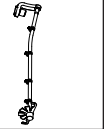

Rear handle
66 81 907



Note!
This handle is included in the Auxiliary O₂ and suction module (see above).

Test Lung 190, adult
60 06 832

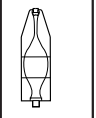

TEST LUNG

CO₂ ABSORBER

Reusable

Reusable CO₂ absorber
 66 92 582
 • Including:
 - 10 pcs of Dust filter for reusable CO₂ absorber.

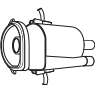

Disposable

CO₂ absorber (disposable),
 12 pcs/pkg
 66 77 845



Extra filter

Dust filter for reusable CO₂ absorber,
 40 pcs/pkg
 68 80 430



EXTRA BREATHING SYSTEM PARTS

36

Extra Patient cassette
 66 80 325

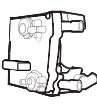

Extra Volume reflector
 66 80 327
 • Including:
 - Reflector socket



CLEANING ADAPTER

Cleaning adapter kit
 66 81 910



MCARE SERVICES

Remote service

FLOW-i Remote services adapter
 66 96 757
 • Including:
 - Installation instructions.



MAQUET
 MCARE
MCare Preventive
 • Including:
 - Telephone support.
 - Preventive service.
 - Maintenance kits.
 - User training.

MAQUET
 MCARE
MCare Plus
 • Including:
 - Telephone support.
 - Preventive service.
 - Corrective service.
 - (Selected spare parts).
 - Maintenance kits.
 - Updates.
 - User training.

MAQUET
 MCARE
MCare Professional
 • Including:
 - Telephone support.
 - Preventive service.
 - Corrective service.
 - Selected spare parts.
 - Maintenance kits.
 - Selected consumables.
 - Updates.
 - User training.

MAQUET
 MCARE
MCare Partner
 • Including:
 - Telephone support.
 - Maintenance kits.
 - (Selected consumables).
 - Updates.
 - Technical training.
 - User training.

Note:

Local variations of MCare may occur.
 For more information contact your local MAQUET office or visit www.maquet.com.

Additional options

- Emergency back-up
- Upgrades
- Quality check
- Consumables discount
- Software options discount
- Accessories discount
- MCare Portal

Contents

■ Base unit	2
■ Country kit	3
■ Starter kit consumables	4
■ Additional ventilation modes	4
■ Gas control modes	4
■ Additional fresh gas flow	4
■ Extra mains power outlets	4
■ Gas outlets	5
■ O ₂ flowmeter / Suction equipment	5
■ Backup gas supply	6
■ Patient monitoring mountings	7
■ Vaporizer	7
■ Gas analyzer accessories	7
■ Gas evacuation (Anesthetic gas scavenging)	8
■ Gas supply	8
■ Manual ventilation	8
■ Viral/bacterial filter	9
■ Patient connection	9
■ Anesthesia mask	10
■ Hardware accessories	10
■ Test lung	11
■ CO ₂ absorber	12
■ Extra breathing system parts	12
■ Cleaning adapter	12
■ MCare Services	12

MAQUET
GETINGE GROUP

For local contact:

Please visit our website
www.maquet.com

MAQUET
GETINGE GROUP

Maquet Critical Care AB
SE-171 54 Solna
SWEDEN
Phone: +46 (0) 8 730 73 00
www.maquet.com

Products may be pending regulatory approvals to be marketed in your country. Contact your MAQUET representative for more information.

GETINGE GROUP is a leading global provider of products and systems that contribute to quality enhancement and cost efficiency within healthcare and life sciences. We operate under the three brands of ArjoHuntleigh, GETINGE and MAQUET. ArjoHuntleigh focuses on patient mobility and wound management solutions. GETINGE provides solutions for infection control within healthcare and contamination prevention within life sciences. MAQUET specializes in solutions, therapies and products for surgical interventions, interventional cardiology and intensive care.