

SYSTEM FLOW CHART

MAQUET
GETINGE GROUP

**VENTILATION
SERVO-U**



SERVO-U, VERSION 1.1

BASE UNIT

FOR NEW VENTILATORS:

Base unit SERVO-U
66 94 800











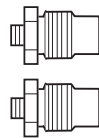

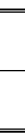
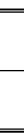











Included hardware

- User interface.
- Patient unit.
- Battery module, 2 pcs.
- Expiratory cassette, 1 pcs.
- Test tube, grey.
- Test Lung 190, adult.
- Test Lung 191, neonatal.
- Aeroneb cable.
- Aeroneb Solo nebulizer.
- Aeroneb Solo adult T-adapter with plug, disposable.
- Installation instructions.
- Plastic cover panel mount (for Panel holder mount).
- Country kit and O₂ sensor/O₂ cell must be ordered separately (see below).

Included software

- Adult patient category, tidal volume 100-4000 ml.
- Pediatric patient category, tidal volume 10-350 ml.
- Invasive ventilation modes:
 - NAVA.
 - Pressure Support (PS)/CPAP.
 - Pressure Control (PC).
 - Volume Control (VO).
 - PRVC.
 - Volume Support (VS).
 - Bi-Vent/APRV.
 - SIMV(PC) + PS.
 - SIMV(VC) + PS.
 - SIMV(PRVC) + PS.
- Nebulizer.

COUNTRY KIT

SERVO-U country kit		Gas connections	Mains power cable	Order no
	Bulgarian *	NIST	European	68 80 495
	Czech	AGA	European	66 93 602
	Danish	AGA	European	66 93 605
	Dutch	NIST	European	66 93 607
	English	AGA	European	66 93 610
	English	DISS	North American	68 80 498
	English	NIST	European	66 93 612
	Estonian *	AGA	European	68 80 499
	Finnish	AGA	European	66 93 615
	French	AGA	European	66 93 617
	French	DISS	North American	68 80 520
	French	French standard	European	66 93 620
	French	NIST	European	66 93 622
	German	NIST	European	66 93 625
	Greek	French standard	European	66 93 627
	Hungarian	AGA	European	66 93 630
	Italian	NIST	European	66 93 632
	Lithuanian *	NIST	European	68 80 501
	Norwegian	AGA	European	66 93 635
	Polish	AGA	European	66 93 637
	Portuguese	AGA	European	66 93 640
	Romanian *	NIST	European	68 80 503
	Serbian *	NIST	European	68 80 504
	Slovak	NIST	European	68 80 505
	Spanish	AGA	European	66 93 642
	Spanish/AM	AGA	North American	68 80 506
	Spanish/AM	DISS	North American	68 80 507
	Swedish	AGA	European	66 93 645
	Thai *	DISS	European	68 80 508
	Turkish	NIST	European	68 80 509
	Vietnamese *	NIST	European	68 80 510

* User interface in English, language specific user's manual.

• Including:
 - Gas inlet connections.
 - Mains power cable.
 - User's manual.
 • Alternative mains power cable can be ordered separately (see below).

FOR UPGRADE OF INSTALLED VENTILATORS:

Upgrade via E-delivery, SERVO-U
68 80 519

- Necessary for E-delivery of software option upgrades via the MCC SW download website "<http://swdownload.maquet.com>".
- Including:
 - User's manual.

USB memory stick
68 80 101



Note! Not all products listed here are available in all countries. For details contact your sales representative.

 = and/or
 = box for ordered quantity

Bold line = standard system configuration

Red text = Upgrade of existing ventilators

Green text = Compatibility note

Alternative mains power cable

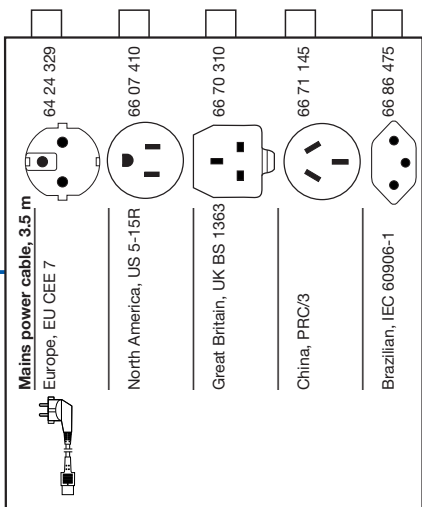

O₂ SENSOR / O₂ CELL

Disposable

O₂ cell, new SERVO ventilator
66 50 118

- Disposable.

O₂ cell for exchange on installed SERVO ventilators: Order no 66 40 044.

Reusable

O₂ sensor, new SERVO ventilator
66 70 680

- Reusable.

O₂ sensor, on-site upgrader: Order no 66 70 600

STARTER KIT CONSUMABLES

One selected kit may be ordered with every ventilator

22 mm patient tubes

Starter kit ventilation adult, 22 mm (for passive humidification)
66 96 807

- Including:
 - 1 pc of Breathing system for HME, disposable 22 mm (20 pcs: 66 91 957).
 - 1 pc of SERVO Humidifier 162 (100 pcs: 64 19 357).
 - 1 pc of SERVO DuoGuard viral/bacterial filter (60 pcs: 66 71 775).
 - 1 pc of NIV reusable face mask, Medium (10 pcs: 66 91 975).
 - 1 pc of NIV face mask, disposable, Size L (20 pcs: 66 91 985).

15 mm patient tubes

Starter kit ventilation pediatric, 15 mm (for passive humidification)
66 96 705

- Including:
 - 1 pc of Breathing system for HME, disposable 15 mm (20 pcs: 66 91 960).
 - 1 pc of SERVO Humidifier 162 (100 pcs: 64 19 357).
 - 1 pc of SERVO DuoGuard viral/bacterial filter (60 pcs: 66 71 775).
 - 1 pc of NIV reusable face mask, Small (10 pcs: 66 91 972).
 - 1 pc of NIV face mask, disposable, Size S (20 pcs: 66 91 980).

10 mm patient tubes

Starter kit ventilation neonatal, 10 mm (for active humidification)
68 80 511

- Including:
 - 2 pcs of Breathing system for dual heated active humidification 10 mm, insp. limb 2 m, disposable (10 pcs: 66 93 742).
 - 2 pcs of SERVO DuoGuard viral/bacterial filter (60 pcs: 66 71 775).

EXTRA EXPIRATORY CASSETTE

Expiratory cassette, SERVO-U
66 93 752

One Expiratory cassette is delivered with each base unit.

SOFTWARE OPTIONS

Software Automode®, SERVO-U
66 93 655

- Automode PC <-> PS.
- Automode PRVC <-> VS.
- Automode VC <-> VS.

Software NIV, SERVO-U
68 80 513

- NIV PS.
- NIV PC.

Software Neonatal, SERVO-U
68 80 514

- Tidal Volume 2-50 ml.
- Leakage compensation for invasive ventilation modes.
- Neonatal alarm management.
- Software Y sensor.

Software Nasal CPAP, SERVO-U
68 80 515

Software Alarm output, SERVO-U
68 80 516

- 6 plug-in slots for modules are available.
- Each battery module occupies 1 slot (2 battery modules are delivered with each base unit).
 - 1 slot is occupied if the Edi module is selected.
 - 1 slot is occupied if the Y sensor module is selected.
 - 2 slots are occupied if the CO2 analyzer module is selected.

NAVA AND Edi MONITORING

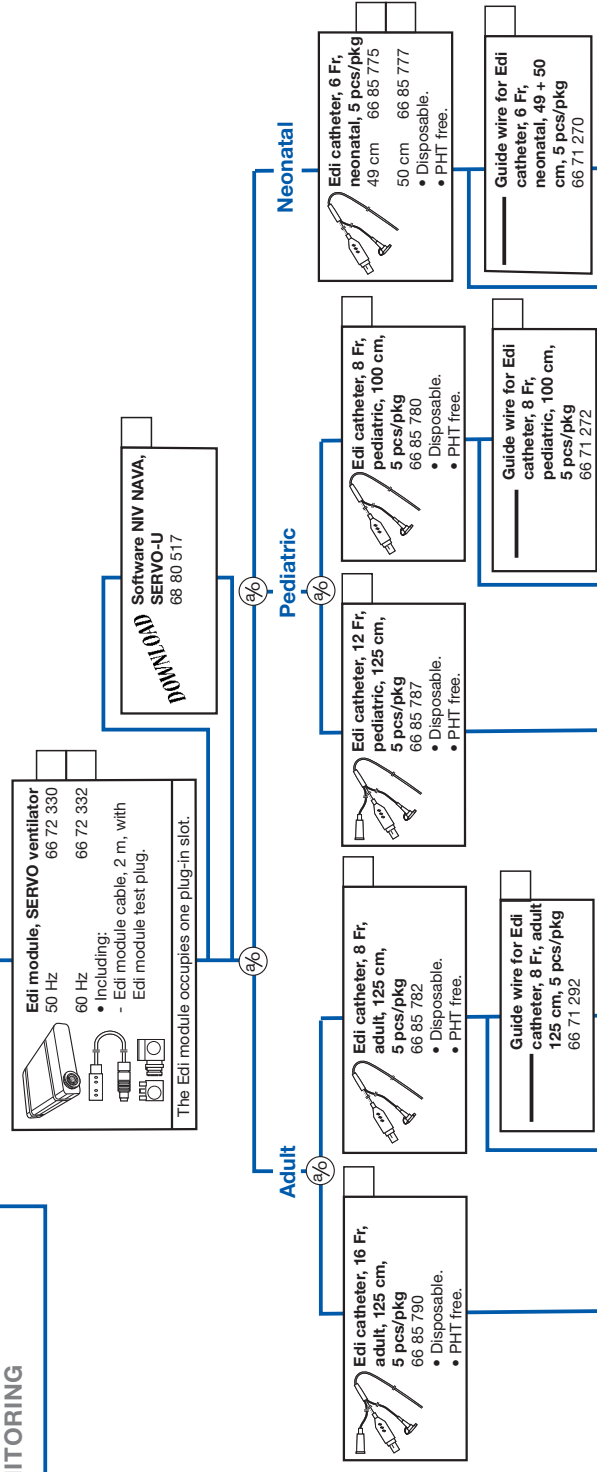

Y SENSOR

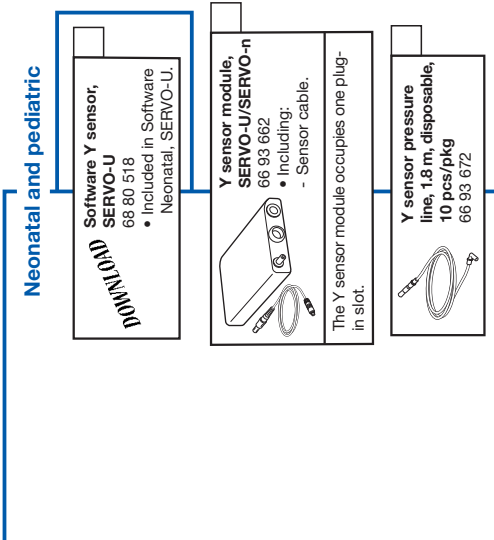



Required if Y sensor is used together with a CO₂ airway adapter



Disposable

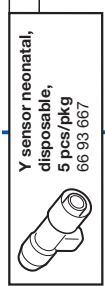

Reusable

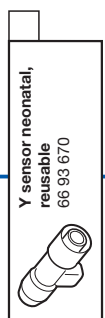

CO₂ ANALYZER

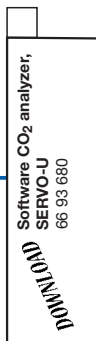

The CO₂ analyzer module occupies two plug-in slots.

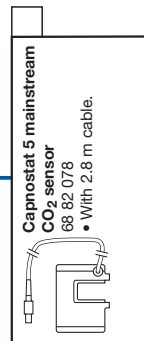

Disposable

Reusable



Neonatal

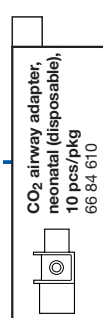

Adult

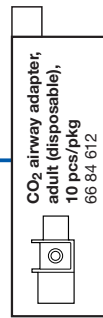

Neonatal



Adult

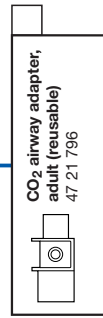

EXTRA BATTERY

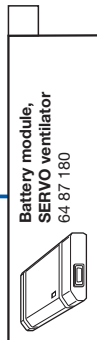

Each battery module occupies one plug-in slot.
Two battery modules are delivered with each base unit.

GAS SUPPLY HOSES

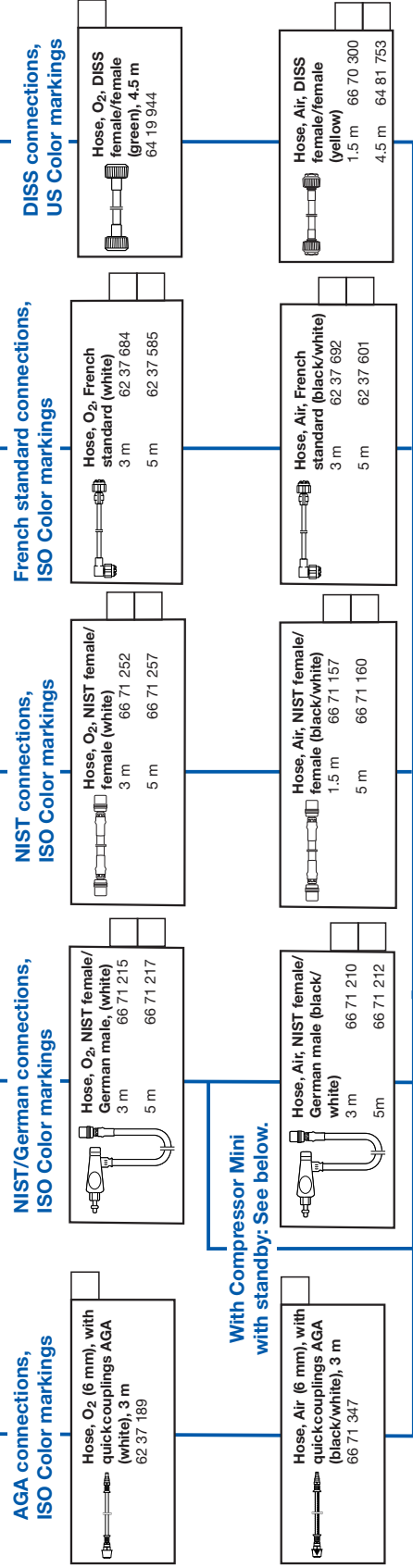

COMPRESSED AIR SUPPLY

Mobile cart, without compressor



Compressor Mini
With standby function
115 V, 60 Hz 64 81 779
230 V, 50/60* Hz 64 81 787

- Including:
- Mounting kit for Compressor Mini on SERVO-*i*/SERVO-*s* Mobile Cart.
- Country kit must be ordered separately (see below).

* For 230 V, 60 Hz usage maintenance interval is shortened, see User's manual.

Note!
Mounting kit for Compressor Mini on Mobile Cart SERVO-U/SERVO-n must be ordered separately (see below).

Mobile cart or Holder, with compressor

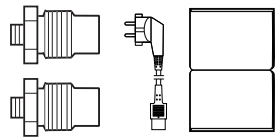

Country kit, Compressor Mini	Gas connections	Pressure unit	Mains power cable	Order no
Bulgarian *	NIST	kPa	European	66 79 130
Chinese *	NIST	kPa	China, PRC/3	66 71 202
Dutch *	NIST	kPa	European	66 71 245
English	AGA	bar	European	66 71 170
English	DISS	psi	European	66 71 165
English	NIST	kPa	European	66 71 172
English US	DISS	psi	North American	66 71 167
Estonian *	AGA	bar	European	66 79 132
French	AGA	bar	European	66 71 185
French	DISS	bar	European	66 71 180
French	French standard	bar	European	66 71 182
French	NIST	bar	European	66 71 187
German	NIST	bar	European	66 71 175
Hungarian *	AGA	kPa	European	66 72 562
Italian	NIST	bar	European	66 71 195
Latvian *	AGA	bar	European	66 73 280
Lithuanian *	NIST	bar	European	66 79 135
Polish *	AGA	bar	European	66 75 205
Portuguese/AM * AGA	kPa	Brazilian	European	66 72 337
Romanian *	NIST	bar	European	66 79 137
Russian *	NIST	kPa	European	66 71 200
Slovak *	NIST	kPa	European	66 71 557
Spanish	AGA	kPa	European	66 71 192
Spanish	AGA	kPa	North American	66 71 190
Swedish *	AGA	kPa	European	66 71 197
Turkish *	NIST	bar	European	66 71 247

Holder, without compressor

- User interface in English, language specific user's manual.
- Including:
 - Air connections.
 - Mains power inlet cable.
 - User's manual.
- Alternative mains power cable can be ordered separately (see above, under Country kit).
- Separate gas connections can be ordered. Contact your MAQUET representative for further information.

AGA connections, ISO Colour markings

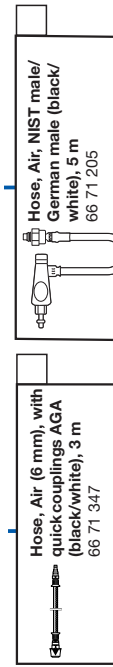

Hose, Air (6 mm), with quick couplings AGA (black/white), 3 m
66 71 347

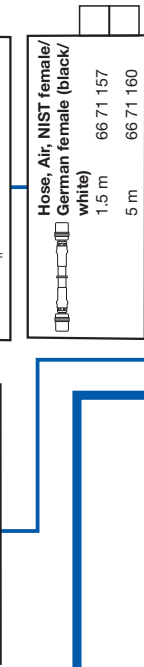

Hose, Air, NIST male/German male (black/white), 5 m
66 71 205

Hose, Air, NIST female/German female (black/white)
1.5 m 66 71 157
5 m 66 71 160

Standby air connection

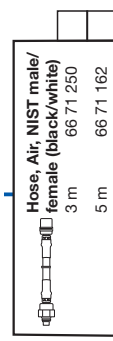

Hose, Air, NIST male/female (black/white)
3 m 66 71 250
5 m 66 71 162

Without standby connection

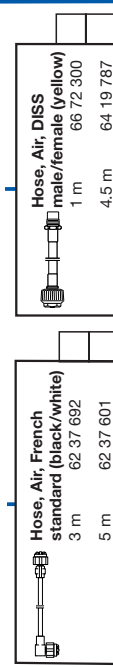

Hose, Air, French standard (black/white)
3 m 62 37 692
5 m 62 37 601



Hose, Air, DISS male/female (yellow)
1 m 66 72 300
4.5 m 64 19 787

AGA connections, ISO Colour markings

NIST/German connections, ISO Color markings

NIST connections, ISO Colour markings

French standard connections, ISO Colour markings

DISS connections, US Colour markings

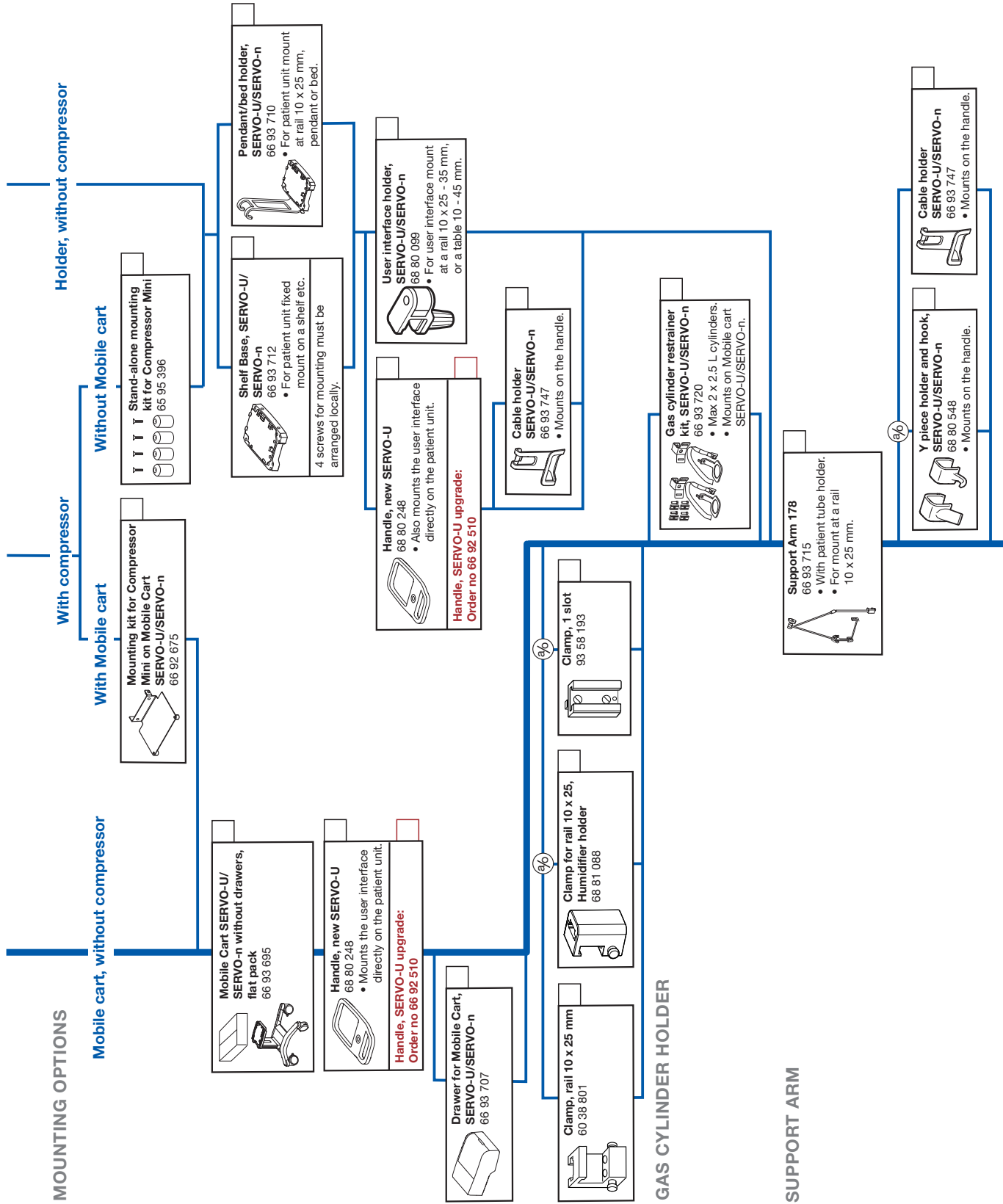

NEBULIZER

Reusable patient connection (Aeroneb Pro)

Aeroneb Pro nebulizer unit with filler cap
66 47 841



Adult, 22 mm patient tubes

Aeroneb Pro adult T-adapter with plug, 5 pcs/pkg
66 47 817

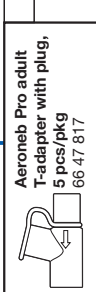

Pediatric/Neonatal, 15 or 10 mm patient tubes

Aeroneb Pro pediatric T-adapter with plug, 5 pcs/pkg
66 47 825

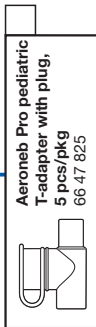

15 mm patient tubes

Aeroneb Pro neonatal adapter kit, 5 pcs/pkg
66 47 833

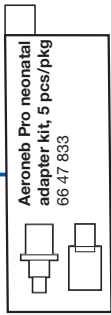

Patient tube 10 mm, 30 cm Hytrel, 5 pcs
66 92 452

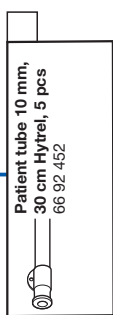

Extra Aeroneb Pro accessories

Aeroneb Pro filler cap, 5 pcs/pkg
66 47 866

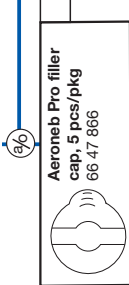

Aeroneb Pro silicone rubber plug for T-adapter, 5 pcs/pkg
66 47 874



Disposable patient connection (Aeroneb Solo)

Kit for 22 mm patient tubes
5 pcs/pkg 66 75 742
10 pcs/pkg 66 75 745

- Including:
 - Aeroneb Solo nebulizer, 5/10 pcs.
 - Aeroneb Solo adult T-adapter with plug, disposable, 5/10 pcs.
- One piece is included in the Base unit.

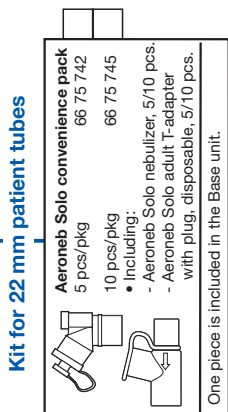

Aeroneb Solo nebulizer
5 pcs/pkg 66 75 672
10 pcs/pkg 66 75 675

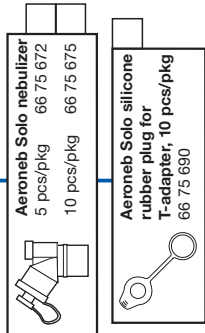

Aeroneb Solo silicone rubber plug for T-adapter, 10 pcs/pkg
66 75 690

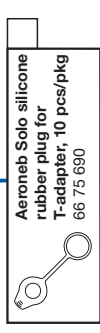

22 mm patient tubes

Aeroneb Solo adult T-adapter, disposable, 10 pcs/pkg
66 75 677

- Without plug.

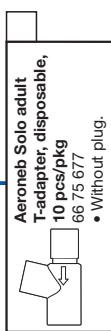

12 mm patient tubes

Aeroneb Solo neonatal T-adapter, disposable, 12 mm male/female, 10 pcs/pkg
66 75 685

- Without plug.

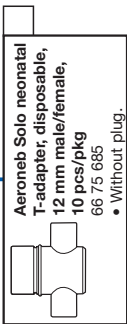

10 mm patient tubes

Aeroneb Solo pediatric T-adapter and Neonatal adapter kit, disposable, 10 pcs/pkg
66 75 682

- T-adapter without plug.



Aeroneb Solo pediatric T-adapter, disposable, 10 pcs/pkg
66 75 680

- Without plug.

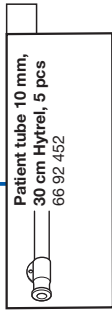

Patient tube 10 mm, 30 cm Hytrel, 5 pcs
66 92 452

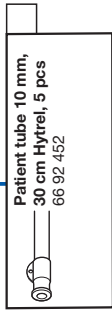

Continuous nebulization

Aeroneb continuous nebulization syringe, 5 pcs/pkg
66 86 730

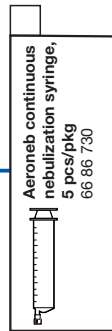

Aeroneb continuous nebulization tube set, 5 pcs/pkg
66 86 732

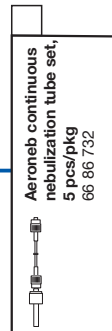

Servo DuoGuard viral/bacterial filter, 60 pcs/pkg
66 71 775

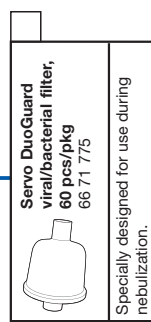

Specially designed for use during nebulization.

EXTERNAL CONNECTIONS

USB memory stick
68 80 101

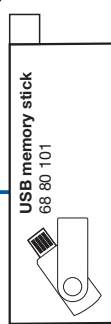

Data cable SERVO ventilator to PC, 2.4 m
65 23 570

- 9 pin female PC plug.

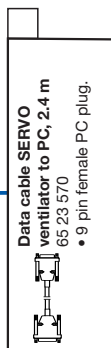

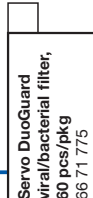

VIRAL/BACTERIAL FILTER

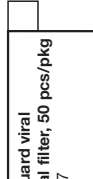

Servo DuoGuard viral/bacterial filter,
60 pcs/pkg
66 71 775

Specially designed for use during nebulization.



Servo Guard viral/bacterial filter,
50 pcs/pkg
66 95 487

Specially designed for use when rainout is present in the expiratory breathing circuit.

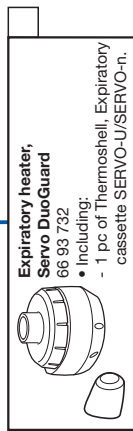

Expiratory heater, Servo DuoGuard
66 93 732

- Including:
 - 1 pc of Thermoshell, Expiratory cassette SERVO-U/SERVO-n.

HEAT AND MOISTURE EXCHANGER (HME)

Alt. 1: Passive humidification (HME)

Alt. 2: Active humidification (Heater humidifier)

Regular volume

Regular volume

Regular volume

Regular volume

Small volume

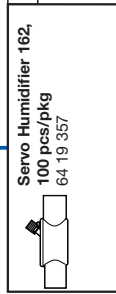

Servo Humidifier 162,
100 pcs/pkg
64 19 357

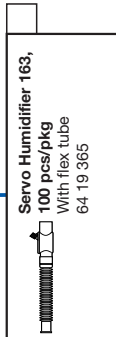

Servo Humidifier 163,
100 pcs/pkg
With flex tube
64 19 365

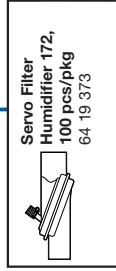

Servo Filter Humidifier 172,
100 pcs/pkg
64 19 373

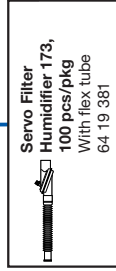

Servo Filter Humidifier 173,
100 pcs/pkg
With flex tube
64 19 381

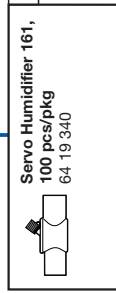

Servo Humidifier 161,
100 pcs/pkg
64 19 340

PATIENT BREATHING SYSTEM – HME

Patient connection

Reusable

Disposable

22 mm patient tubes

15 mm patient tubes

10 mm patient tubes

22 mm patient tubes

15 mm patient tubes

10 mm patient tubes

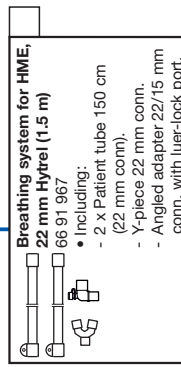

Breathing system for HME,
22 mm Hytrel (1.5 m)
66 91 967

- Including:
 - 2 x Patient tube 150 cm (22 mm conn).
 - Y-piece 22 mm conn.
 - Angled adapter 22/15 mm conn. with luer-lock port.

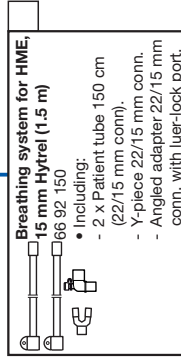

Breathing system for HME,
15 mm Hytrel (1.5 m)
66 92 150

- Including:
 - 2 x Patient tube 150 cm (22/15 mm conn).
 - Y-piece 22/15 mm conn.
 - Angled adapter 22/15 mm conn. with luer-lock port.

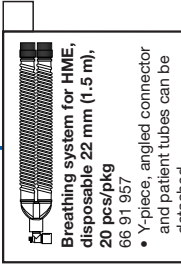

Breathing system for HME,
disposable 22 mm (1.5 m),
20 pcs/pkg
66 91 957

- Y-piece, angled connector and patient tubes can be detached.

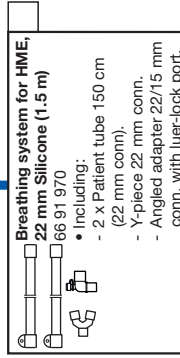

Breathing system for HME,
22 mm Silicone (1.5 m)
66 91 970

- Including:
 - 2 x Patient tube 150 cm (22 mm conn).
 - Y-piece 22 mm conn.
 - Angled adapter 22/15 mm conn. with luer-lock port.

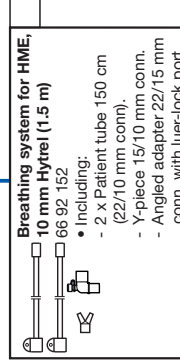

Breathing system for HME,
10 mm Hytrel (1.5 m)
66 92 152

- Including:
 - 2 x Patient tube 150 cm (22/10 mm conn).
 - Y-piece 15/10 mm conn.
 - Angled adapter 22/15 mm conn. with luer-lock port.

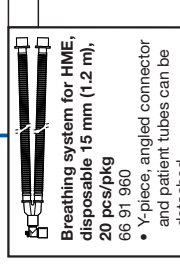

Breathing system for HME,
disposable 15 mm (1.2 m),
20 pcs/pkg
66 91 960

- Y-piece, angled connector and patient tubes can be detached.

Alt. 2: Active humidification (Heater humidifier)

Mount at Mobile cart or rail 10 x 25 mm

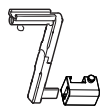

Humidifier Holder SERVO-U/SERVO-n
66 93 735

- Including:
 - Clamp for rail 10 x 25, Humidifier holder.
 - For mount at a rail 10 x 25 mm, or slot mount.



Waterbag/IV pole SERVO-U/SERVO-n
66 93 722

- Max load 1.5 kg.

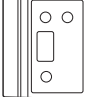

Fisher & Paykel Humidifier MR 850

230 V, English/Spanish/French text, mains power cable without plug	65 45 185
230 V, English/Spanish/French text, mains power cable without plug	65 95 115
230 V, German/French/Italian text, European mains power plug	65 95 222
230 V, Italian/Spanish/Portuguese text, European mains power plug	66 47 502
230 V, Danish text, Danish mains power plug	66 47 510
230 V, English text, Australia/New Zealand mains power plug	66 47 528
230 V, English text, Great Britain mains power plug	66 47 536
230 V, French/Dutch/German text, European mains power plug	66 47 536
230 V, Norwegian/Swedish/Finnish text, European mains power plug	66 47 544
230 V, English/Russian/Polish text, European mains power plug	66 47 551
115 V, English/Spanish/French text, North Am. right angle mains power plug	65 45 193
115 V, Spanish/Portuguese/English text, North Am. right angle mains power plug	66 47 569
100 V, Japanese text, North American straight mains power plug	65 45 201



Teleflex Neptune adapter for Humidifier Holder
68 80 102

Teleflex ConchaTherm Neptune Heated Humidifier and accessories
Local delivery.



Fisher & Paykel cable, temperature and flow probe MR 850, 1.5 m
65 95 255

Alt. 1: Passive humidification (HME)

Alt. 2: Active humidification (Heater humidifier)

Alt. 2: Active humidification (Heater humidifier)

**PATIENT BREATHING SYSTEM
- HEATER HUMIDIFIER**

Reusable

Fisher & Paykel kit of accessories MR 850, reusable
65 95 057

- Including:
 - Heater wire with probe housing.
 - Probe housing adult.
 - Draw wire.
 - Cable clip adult, 3 pcs.
 - Cable clip infant, 3 pcs.
 - Connection cable for reusable tube heater.
 - Tube joint 22 mm out. diam., 15 mm int. diam.



22 mm patient tubes

Fisher & Paykel humidifying chamber (autoclavable), adult
61 50 754



15/10 mm patient tubes

Fisher & Paykel humidifying chamber (autoclavable), infant
91 54 295



Disposable

22 mm patient tubes

Breathing system 22 mm for single heated active humidification, insp. limb 1.5 m, Hytrel
66 91 962

- Including:
 - Patient tube 30 cm (22 mm conn).
 - 2 x Patient tube 60 cm (22 mm conn).
 - Patient tube with temp port 110 cm (22 mm conn).
 - Y-piece 22 mm conn.
 - Angled adapter 22/15 mm conn. with luer-lock port.
 - Adapter 22 mm conn.
 - Water trap.

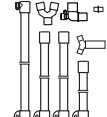

15 mm patient tubes

Breathing system 15 mm for single heated active humidification, insp. limb 1.5 m, Hytrel
66 92 155

- Including:
 - Patient tube 30 cm (22/15 mm conn).
 - Patient tube 60 cm (22/15 mm conn).
 - Patient tube with temp port 110 cm (22/15 mm conn).
 - Y-piece 22/15 mm conn.
 - Angled adapter 22/15 mm conn. with luer-lock port.
 - Adapter 22/15 mm conn.
 - Adapter 15 mm conn.
 - Water trap.

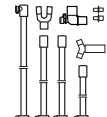

10 mm patient tubes

Breathing system 10 mm for single heated active humidification, insp. limb 1.5 m, Silicone
66 92 162

- Including:
 - Patient tube 30 cm (10 mm conn).
 - Patient tube 30 cm (22/15 mm conn).
 - Patient tube 60 cm (22 mm conn).
 - Patient tube 60 cm (22/10 mm conn).
 - Patient tube with temp port 110 cm (22/10 mm conn).
 - Y-piece 15/10 mm conn.
 - Angled adapter 22/15 mm conn. with luer-lock port.
 - Adapter 15 mm conn.
 - Adapter 10 mm conn.
 - Water trap.

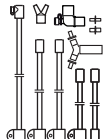

Breathing system 10 mm for single heated active humidification, insp. limb 1.5 m, Hytrel
66 92 157

- Including:
 - Patient tube 30 cm (10 mm conn).
 - Patient tube 30 cm (22/15 mm conn).
 - Patient tube 60 cm (22 mm conn).
 - Patient tube 60 cm (22/10 mm conn).
 - Patient tube with temp port 110 cm (22/10 mm conn).
 - Y-piece 15/10 mm conn.
 - Angled adapter 22/15 mm conn. with luer-lock port.
 - Adapter 15 mm conn.
 - Adapter 10 mm conn.
 - Water trap.

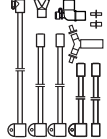

Breathing system 22 mm for single heated active humidification, insp. limb 1.5 m, Silicone
66 91 965

- Including:
 - Patient tube 30 cm (22 mm conn).
 - 2 x Patient tube 60 cm (22 mm conn).
 - Patient tube with temp port 110 cm (22 mm conn).
 - Y-piece 22 mm conn.
 - Angled adapter 22/15 mm conn. with luer-lock port.
 - Adapter 22 mm conn.
 - Water trap.

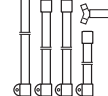

Reusable

Disposable

Single heated

Dual heated

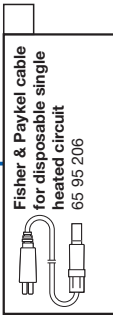

22 mm patient tubes

10 mm patient tubes

22 mm patient tubes

10 mm patient tubes

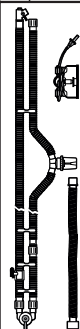

Breathing system for single heated active humidification 22 mm, insp. limb 2.1 m, disposable, 10 pcs/pkg
66 92 165

- Including:
 - Heated inspiratory limb, 1.5 m.
 - Expiratory limb with water trap, 1.8 m.
 - Humidifier connection tube, 0.5 m.
 - Autofeed adult/pediatric humidification chamber.

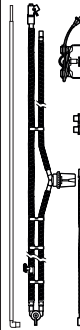

Breathing system for single heated active humidification 10 mm, insp. limb 2.2 m, disposable, 10 pcs/pkg
66 92 170

- Including:
 - Heated inspiratory limb, 1.1 m.
 - Expiratory limb with water trap, 1.6 m.
 - Inspiratory tube, 0.3 m.
 - Humidifier connection tube, 0.6 m.
 - Pressure line, 1.8 m.
 - Autofeed neonatal/pediatric humidification chamber.

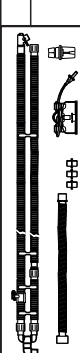

Breathing system for dual heated active humidification 22 mm, insp. limb 2 m, disposable, 10 pcs/pkg
66 93 737

- Including:
 - Heated inspiratory limb, 1.5 m.
 - Heated expiratory limb, 1.5 m.
 - Humidifier connection tube, 0.5 m.
 - Autofeed adult/pediatric humidification chamber.



Breathing system for dual heated active humidification 10 mm, insp. limb 2 m, disposable, 10 pcs/pkg
66 93 742

- Including:
 - Heated inspiratory limb, 1.1 m.
 - Heated expiratory limb, 1.4 m.
 - Inspiratory tube, 0.3 m.
 - Humidifier connection tube, 0.6 m.
 - Pressure line, 1.8 m.
 - Autofeed neonatal/pediatric humidification chamber.



ThermoShell, Expiratory cassette
SERVO-U/SERVO-n, 5 pcs/pkg
68 80 848

- To be used when dual heat circuits are used with SERVO-U and SERVO-n.

PATIENT INTERFACE

Alt. 2: Active humidification (Heater humidifier)

Non Invasive Ventilation Masks
Adult + Pediatric

Disposable

NIV face mask, disposable

Size S, 20 pcs/pkg 66 91 980
 Size M, 20 pcs/pkg 66 91 982
 Size L, 20 pcs/pkg 66 91 985

- Each piece including:
 - 1 NIV disposable face mask.
 - 1 headgear.



Reusable

NIV reusable face mask

Small, 10 pcs/pkg (small headgear size) 66 91 972
 Medium, 10 pcs/pkg (standard headgear size) 66 91 975
 Large, 10 pcs/pkg (standard headgear size) 66 91 977

- Each piece including:
 - 1 NIV reusable face mask.
 - 1 headgear.

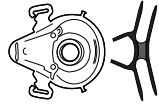

Neonatal
Miniflow neonatal Patient interface system
(a complete system for providing NIV NAVA
and Nasal CPAP)

Miniflow adapter, disposable, 20 pcs/pkg
66 84 635

- Including:
 - Measuring tape (used to select correct bonnet size).

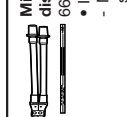

Prong, disposable

Size XS, 10 pcs/pkg 66 84 645
 Size S, 10 pcs/pkg 66 84 647
 Size M, 10 pcs/pkg 66 84 650
 Size M-wide, 10 pcs/pkg 66 96 610
 Size L, 10 pcs/pkg 66 84 652
 Size XL, 10 pcs/pkg 66 84 655
 Size L-wide, 10 pcs/pkg 66 84 657



Mask neonatal, disposable

Size S, 10 pcs/pkg 66 84 637
 Size M, 10 pcs/pkg 66 84 640
 Size L, 10 pcs/pkg 66 84 642
 Size XL, 10 pcs/pkg 66 88 545



Bonnet, disposable

Size XS, 10 pcs/pkg 66 84 660
 Size S, 10 pcs/pkg 66 84 662
 Size M, 10 pcs/pkg 66 84 665
 Size L, 10 pcs/pkg 66 84 667
 Size XL, 10 pcs/pkg 66 84 670
 Size XXL, 10 pcs/pkg 66 84 672
 Size XXXL, 10 pcs/pkg 66 84 675

- Each piece including:
 - 2 Strips for bonnet.



Extra strip

Strip for disposable bonnet

Size XXS/XS (13 cm), 10 pcs 66 84 677
 Size S/M (15 cm), 10 pcs 66 84 680
 Size L/XL (18 cm), 10 pcs 66 84 682
 Size XXL/XXXL (20 cm), 10 pcs 66 84 685



Neo starter kit

10 patients, 44 pcs 66 84 897
 20 patients, 210 pcs 66 84 900

- Each kit including:
 - Miniflow adapter 10 pcs
 - Measuring tape 10 pcs
 - Prong XS 1 piece
 - Prong S 2 pcs
 - Prong M 2 pcs
 - Prong L 2 pcs
 - Prong XL 1 piece
 - Prong L wide 1 piece
 - Mask S 1 piece
 - Mask M 1 piece
 - Mask M-wide 1 piece
 - Mask L 1 piece
 - Mask XL 1 piece
 - Bonnet XS 1 piece
 - Bonnet S 2 pcs
 - Bonnet M 2 pcs
 - Bonnet L 2 pcs
 - Bonnet XL 1 piece
 - Bonnet XXL 1 piece
 - Bonnet XXXL 1 piece

10 pat. kit: 20 pcs
 20 pat. kit: 20 pcs

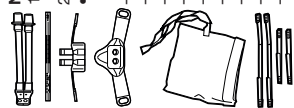

PATIENT CONNECTION OPTIONS

Reusable

Tube connector 22-15 mm, angled, 5 pcs/pkg
90 37 730



Flex tube 15 mm Hytrel
66 92 455

- Including:
 - Adapter 15 mm conn.



EXTRA ACCESSORIES

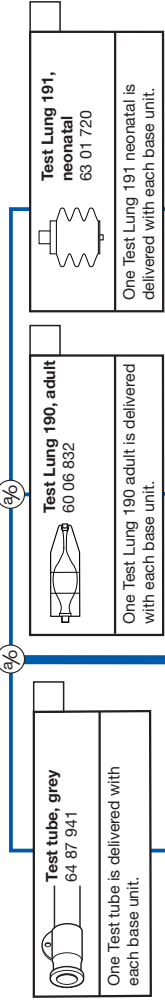

MCARE SERVICES

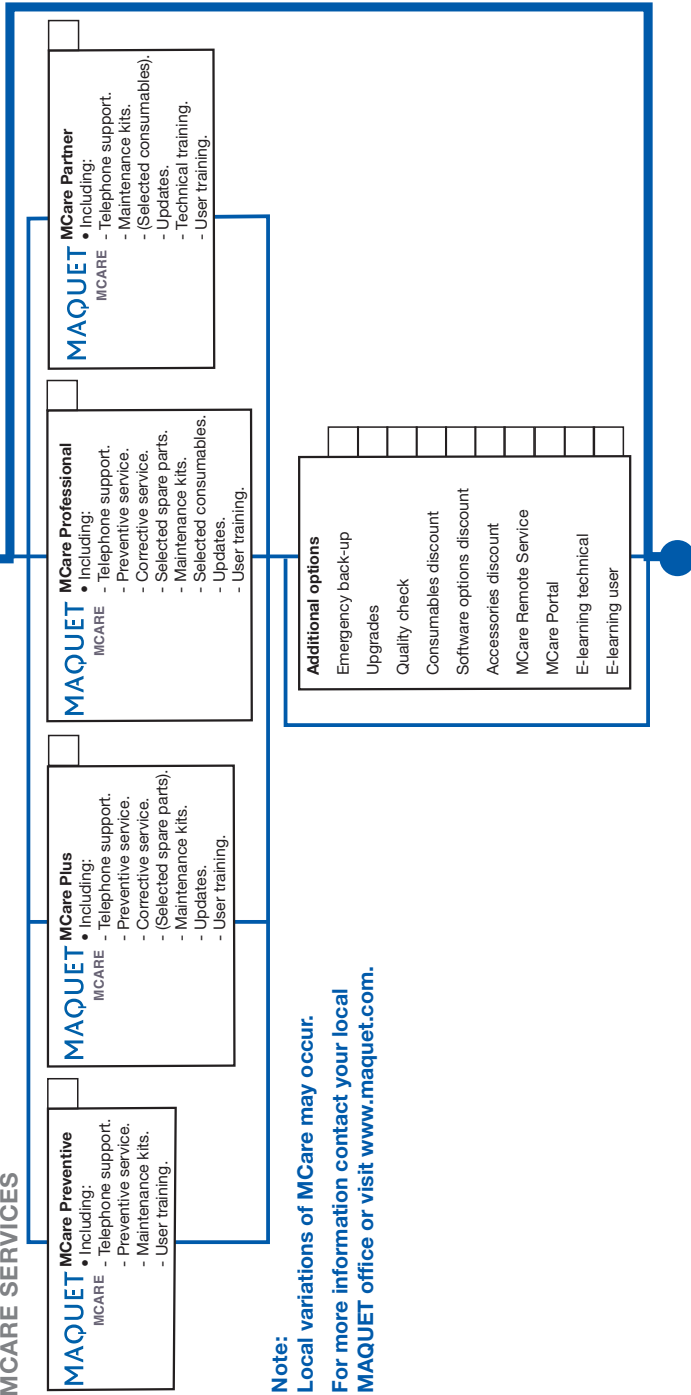

Note:
Local variations of MCare may occur.
For more information contact your local
MAQUET office or visit www.maquet.com.

Contents

■ Base unit	2
■ SERVO-U country kit	2
■ O ₂ sensor / O ₂ cell	3
■ Starter kit consumables	3
■ Extra expiratory cassette	3
■ Software options	3
■ NAVA and Edi monitoring	4
■ Y sensor	4
■ CO ₂ analyzer	5
■ Extra battery	5
■ Gas supply hoses	6
■ Compressed air supply	7
■ Mounting options	8
■ Gas cylinder holder	8
■ Support arm	8
■ Nebulizer	9
■ External connections	9
■ Viral/bacterial filter	10
■ Heat and moisture exchanger (HME)	10
■ Patient breathing system – HME	10
■ Heater humidifier	11
■ Patient breathing system – Heater humidifier	12
■ Patient interface	14
■ Patient connection options	14
■ Extra accessories	15
■ Mcare Services	15

For local contact:

Please visit our website
www.maquet.com

MAQUET

GETINGE GROUP

Maquet Critical Care AB
SE-171 54 Solna
SWEDEN
Phone: +46 (0) 8 730 73 00
www.maquet.com

Products may be pending regulatory approvals to be marketed in your country. Contact your MAQUET representative for more information.

GETINGE GROUP is a leading global provider of products and systems that contribute to quality enhancement and cost efficiency within healthcare and life sciences. We operate under the three brands of ArjoHuntleigh, GETINGE and MAQUET. ArjoHuntleigh focuses on patient mobility and wound management solutions. GETINGE provides solutions for infection control within healthcare and contamination prevention within life sciences. MAQUET specializes in solutions, therapies and products for surgical interventions, interventional cardiology and intensive care.